

# COMBI

## Cajón compacto

Cajón inyectado para módulos hasta 600 mm. Tres longitudes para mayor capacidad. Ahora con la opción de incorporar el sistema de cierre suave **INDAmatic**.



INDAmatic

# 1 CAJÓN COMBI-275

## Cajones

### Cajón COMBI-275.

Módulo	Blanco RAL 9001	
175	680.417.006	25
200	680.420.005	
250	680.425.001	
300	680.430.004	
350	680.435.000	
400	680.440.003	



## Correderas

### Corredera.

Longitud	Pérdida salida PS	Blanco RAL 9001	
275	50	788.116.000	100

Cada referencia se compone de un juego.

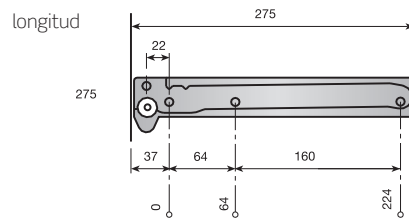
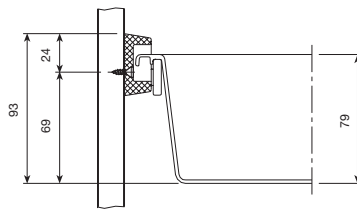

## Enganche del frente

### Enganche frontal regulable.

Blanco RAL 9001	
685.000.002	100

Cada referencia se compone de un juego completo de enganches.

### Enganche frontal regulable con aletas a 15mm.

Blanco RAL 9001	
685.200.003	100

Cada referencia se compone de un juego completo de enganches.

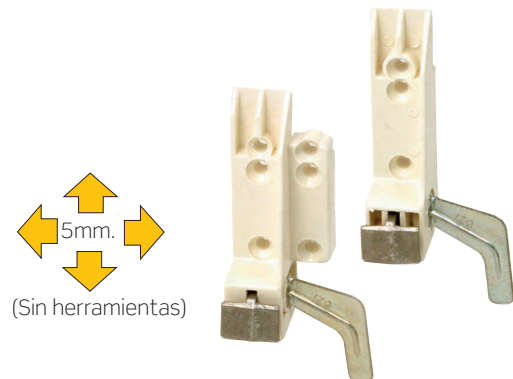

Módulo	F
175	37
200	62
250	112
300	162
350	212
400	262

**NOTA**  
Para la colocación del enganche con aletas hay que sumarle 30mm. a la cota F.

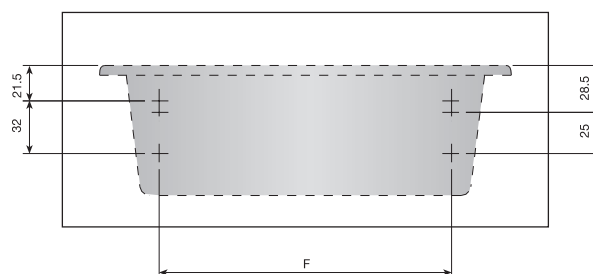

## 2 CAJÓN COMBI-440

### Cajones

#### Cajón COMBI-440.

Módulo	Blanco RAL 9001	Beige RAL 1015	
300	680.330.000	680.330.464	
350	680.335.003	680.335.460	
400	680.340.006	680.340.463	25
450	680.345.002	680.345.466	
500	680.350.005	680.350.462	
600	680.360.004	680.360.461	



#### Cajón COMBI-440 KIT-4.

Módulo	Blanco RAL 9001	
300	681.430.002	
350	681.435.005	
400	681.440.001	1
450	681.445.004	
500	681.450.000	
600	681.460.006	

Cada referencia se compone de 4 cajones con sus correspondientes correderas, enganches, y tirafondos.

#### Cajón COMBI-440 KIT-5.

Módulo	Blanco RAL 9001	
300	681.530.006	
350	681.535.002	
400	681.540.005	1
450	681.545.001	
500	681.550.004	
600	681.560.003	

Cada referencia se compone de 5 cajones con sus correspondientes correderas, enganches, y tirafondos.

Módulo	Anchura	Largo	Alto
300	250	435	79
350	300		
400	350		
450	400		
500	450		
600	550		

### Correderas

#### Correderas para costado de 15÷16mm.

Pérdida de salida PS	Blanco RAL 9001	Beige RAL 1015	
90	789.216.002	789.216.466	100

Cada referencia se compone de un juego.



#### Correderas para costado de 18÷19mm.

Pérdida de salida PS	Blanco RAL 9001	
90	789.219.001	100

Cada referencia se compone de un juego.

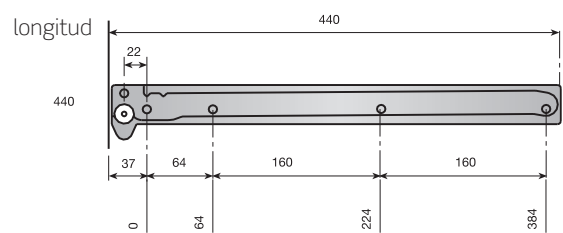
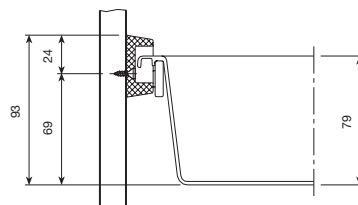

■ Enganche del frente

Enganche frontal regulable.

Blanco RAL 9001	Beige RAL 1015	
685.000.002	685.000.466	100

Cada referencia se compone de un juego completo de enganches.

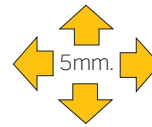

(Sin herramientas)



Enganche frontal regulable con aletas a 15mm.

Blanco RAL 9001	Beige RAL 1015	
685.200.003	685.200.460	100

Cada referencia se compone de un juego completo de enganches.

Módulo	F
300	162
350	212
400	262
450	312
500	362
600	462

**NOTA**

Para la colocación del enganche con aletas hay que sumarle 30mm. a la cota F.

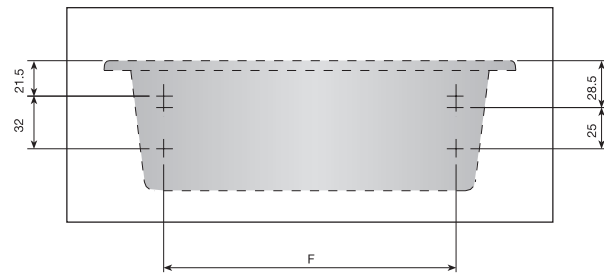

■ Accesorios cajón cacerolero

Cerco para cajón COMBI-440.

Módulo	L	Cromado	
300	230	745.230.124	20
350	280	745.235.120	
400	330	745.240.123	
450	380	745.245.126	
500	430	745.250.122	
600	530	745.260.121	

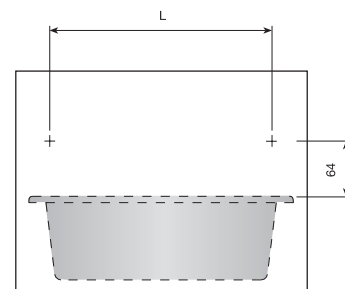
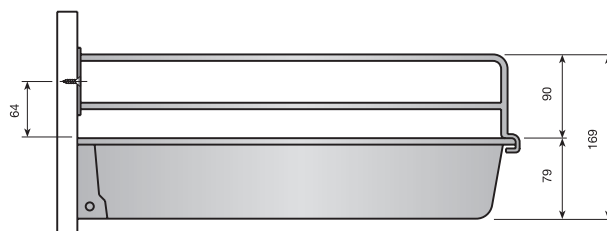

■ **Cuberteros**

Cuberteros diseñados para modulaciones del cajón COMBI. Este cubertero se presenta en dos versiones: ajustado en cuatro lados para todos los módulos, y con faldón lateral para cajones a partir de módulo 350 y 450, dando una mayor versatilidad, ya que sirve para varios modelos.

**Cuberteros COMBI-440.**

Módulo	Blanco	Beige RAL 1015	Medidas			25
			Largo	Ancho	Alto	
300	687.130.006	687.130.463	391	206	45	25
350	689.035.001	689.035.465	391	256	45	20
400	687.140.005	687.140.462	391	306	45	25
450	689.045.000	689.045.464	391	356	45	20
500	689.050.003	689.050.460	391	406	45	20
600	689.060.002	689.060.466	391	506	45	20

Estos cuberteros no llevan faldón, y se ajustan en los cuatro lados del cajón de todos los módulos.



**Cubertero COMBI-440 con aleta.**

Modelo	Blanco	Beige RAL 1015	25
350	687.135.002	687.135.466	25
450	687.145.001	687.145.465	25

Estos cuberteros llevan faldón, y sirven para cajones a partir del módulo 350 y 450 respectivamente.



### 3 CAJÓN COMBI-480

#### ■ Cajones

##### Cajón COMBI-480.

Módulo	Blanco RAL 9001	Gris Metalizado	
300	681.030.000	681.030.313	25
350	681.035.003	681.035.316	
400	681.040.006	681.040.312	
450	681.045.002	681.045.315	
500	681.050.005	681.050.311	
600	681.060.004	681.060.310	

Se suministra en cajas de 25 unidades.



##### Cajón COMBI-480 KIT-4.

Módulo	Blanco RAL 9001	Gris Metalizado	
300	681.130.004	681.130.310	1
350	681.135.000	681.135.313	
400	681.140.003	681.140.316	
450	681.145.006	681.145.312	
500	681.150.002	681.150.315	
600	681.160.001	681.160.314	

Cada referencia se compone de 4 cajones con sus correspondientes correderas, enganches y tirafondos.



##### Cajón COMBI-480 KIT-5.

Módulo	Blanco RAL 9001	Gris Metalizado	
300	681.230.001	681.230.314	1
350	681.235.004	681.235.310	
400	681.240.000	681.240.313	
450	681.245.003	681.245.316	
500	681.250.006	681.250.312	
600	681.260.005	681.260.311	

Cada referencia se compone de 5 cajones con sus correspondientes correderas, enganches y tirafondos.

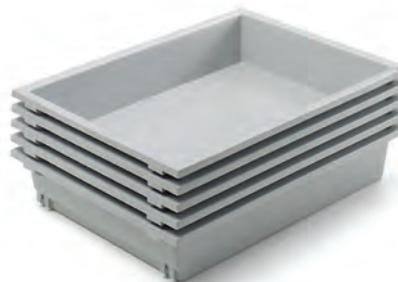

■ Correderas

Corredera costado 15÷16mm.

Ps	Blanco RAL 9001	Gris Metalizado	
90	788.316.001	788.316.314	100

Cada referencia se compone de un juego.

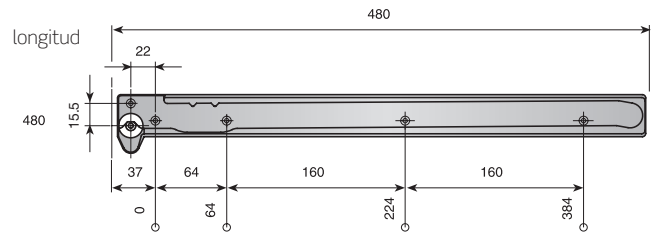
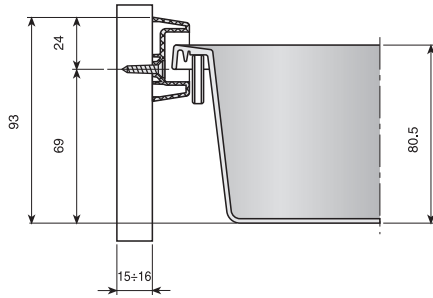

■ Enganche del frente

Enganche frontal regulable.

	Blanco RAL 9001	Gris Metalizado	
	685.000.002	685.000.315	100

Cada referencia se compone de un juego completo de enganches.

Enganche frontal regulable con aletas a 15mm.

	Blanco RAL 9001	Gris Metalizado	
	685.200.003	685.200.316	100

Cada referencia se compone de un juego completo de enganches.

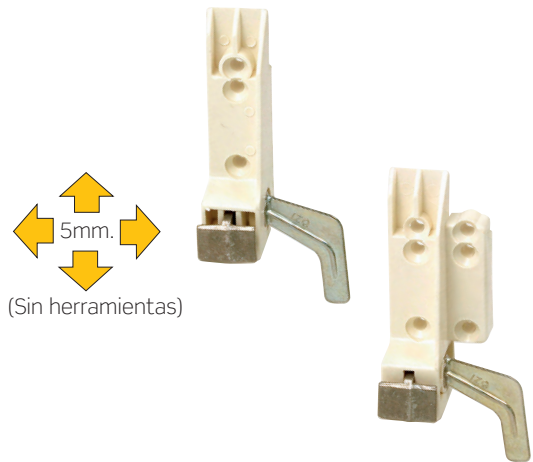

Módulo	F
300	162
350	212
400	262
450	312
500	362
600	462

**NOTA**  
para la colocación del enganche con aletas hay que sumarle 30mm. a la cota F.

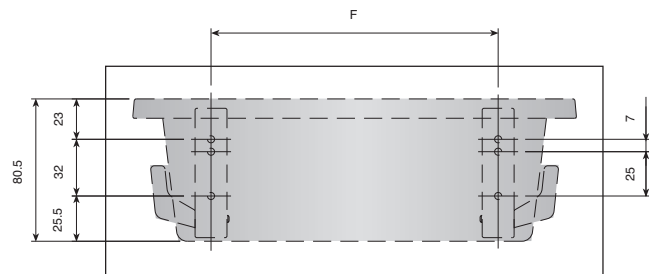

■ Accesorios cajón cacerolero

**Cerco para cajón COMBI-480.**

Módulo	L	Cromado	
300	230	745.330.121	20
350	280	745.335.124	
400	330	745.340.120	
450	380	745.345.123	
500	430	745.350.126	
600	530	745.360.125	

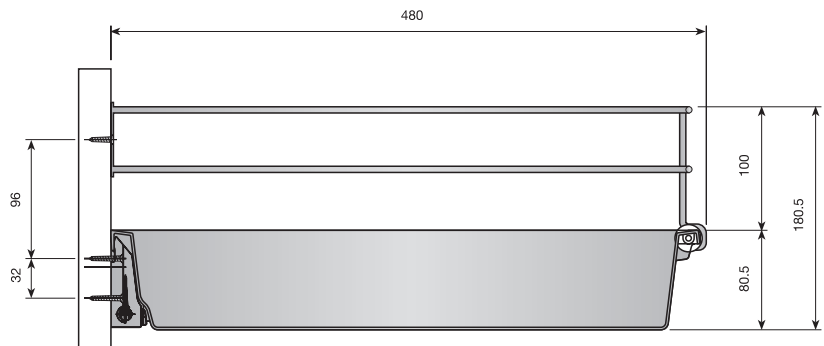
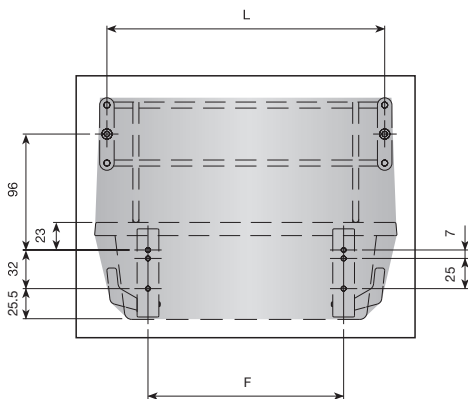
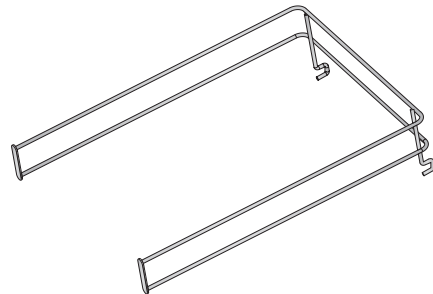

■ Cuberteros

Cuberteros diseñados para modulaciones del cajón COMBI. Este cubertero se presenta en dos versiones: ajustado en cuatro lados para todos los módulos, y con faldón lateral para cajones a partir de módulo 350 y 450, dando una mayor versatilidad, ya que sirve para varios modelos.

**Cubertero COMBI-480.**

Módulo	Blanco RAL 9001	Gris Metalizado	
300*	687.930.003	687.930.316	20
350	687.635.001	687.635.314	
400*	687.940.002	687.940.315	
450	687.645.000	687.645.313	
500	687.650.003	687.650.316	
600	687.660.002	687.660.315	

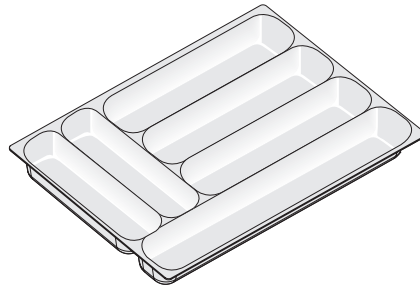

**Cubertero COMBI-480 con aleta.**

Módulo	Blanco RAL 9001	Gris Metalizado	
350	687.935.006	687.935.312	25
450	687.945.005	687.945.311	

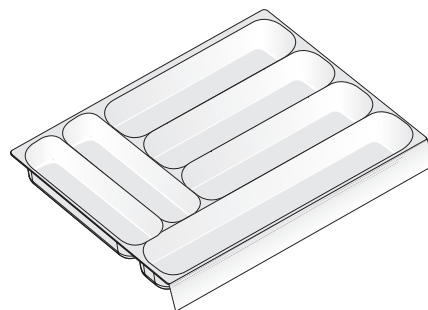

Estos cuberteros llevan faldón, y sirven para cajones a partir del módulo 350 y 450 respectivamente.



■ Accesorios: Esterilla antideslizante

Esterilla antideslizante para depositar en todos los cajones, especialmente caceroleros y evitar de esta manera el desplazamiento de los elementos de cocina y el rayado del fondo. Se puede cortar directamente del rollo a la medida del cajón.

Esterilla antideslizante.

Gris	443.050.300	1
------	-------------	---

Se suministra en rollos de 20mts. de longitud y 500mm. de ancho.

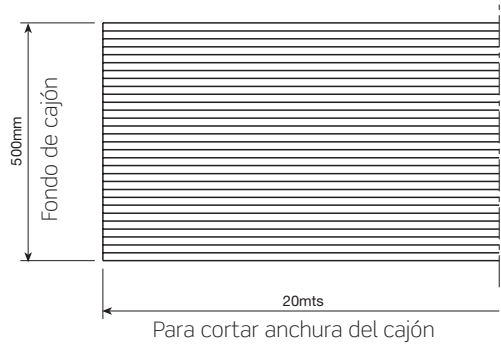

■ COMBI-480 INDAmatic



**Conjunto amortiguador + horquilla para COMBI-480.**

			
Blanco	RAL 9001	198.900.004	50
Gris	RAL 7040	198.900.310	

Cada referencia se compone de 1 amortiguador y 1 horquilla.



**Cajón COMBI-480 con alojamiento INDAmatic.**

Módulo	Blanco RAL 9001	Gris Metalizado	
300	683.230.004	683.230.310	25
350	683.235.000	683.235.313	
400	683.240.003	683.240.316	
450	683.245.006	683.245.312	
500	683.250.002	683.250.315	
600	683.260.001	683.260.314	

Se suministra en cajas de 25 unidades.



**Cajón COMBI-480 con alojamiento INDAmatic. KIT-4.**

Módulo	Blanco RAL 9001	Gris Metalizado	
300	686.330.002	686.330.315	1
350	686.335.005	686.335.311	
400	686.340.001	686.340.314	
450	686.345.004	686.345.310	
500	686.350.000	686.350.313	
600	686.360.006	686.360.312	

Cada referencia se compone de 4 cajones con sus correspondientes correderas, enganches, tirafondos y conjunto INDAmatic.



**Cajón COMBI-480 con alojamiento INDAmatic. KIT-5.**

Módulo	Blanco RAL 9001	Gris Metalizado	
300	686.430.006	686.430.312	1
350	686.435.002	686.435.315	
400	686.440.005	686.440.311	
450	686.445.001	686.445.314	
500	686.450.004	686.450.310	
600	686.460.003	686.460.316	

Cada referencia se compone de 5 cajones con sus correspondientes correderas, enganches, tirafondos y conjunto INDAmatic.

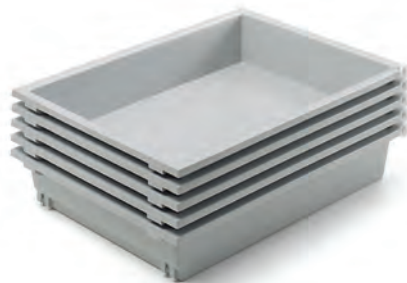

> Correderas

Corredera costado 15÷16mm.

Ps	Blanco RAL 9001	Gris Metalizado	
90	788.316.001	788.316.314	100

Cada referencia se compone de un juego.

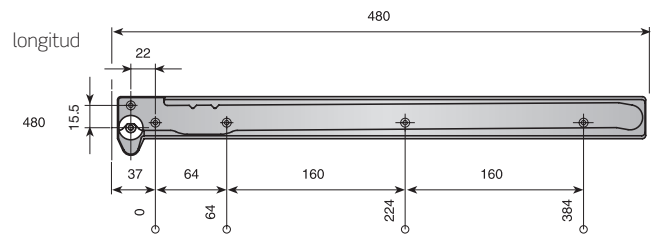
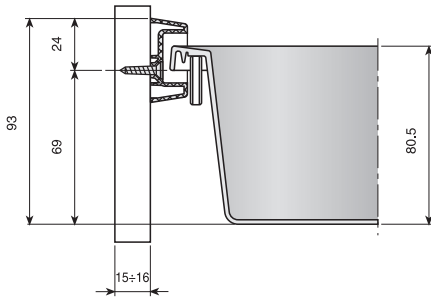

> Enganche del frente

Enganche frontal regulable.

	Blanco RAL 9001	Gris Metalizado	
	685.000.002	685.000.315	100

Cada referencia se compone de un juego completo de enganches.

Enganche frontal regulable con aletas a 15mm.

	Blanco RAL 9001	Gris Metalizado	
	685.200.003	685.200.316	100

Cada referencia se compone de un juego completo de enganches.

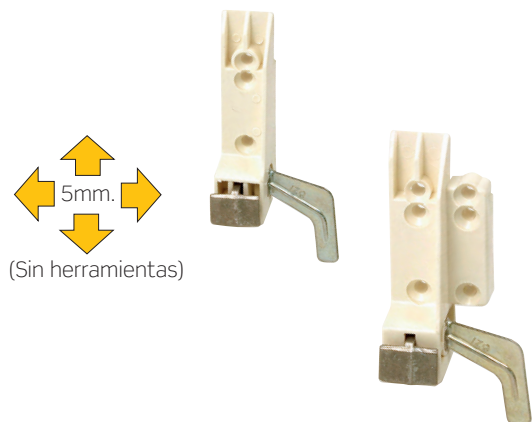

Módulo	F
300	162
350	212
400	262
450	312
500	362
600	462

**NOTA**  
para la colocación del  
enganche con aletas hay que  
sumarle 30mm. a la cota F.

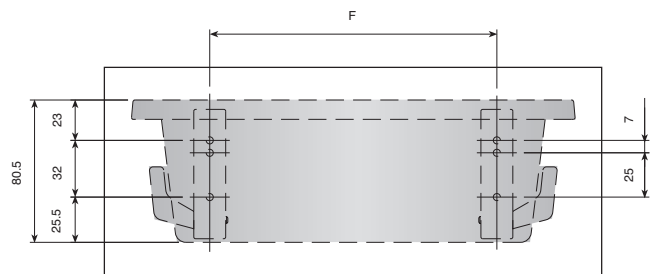

Montaje

Fijacion al costado

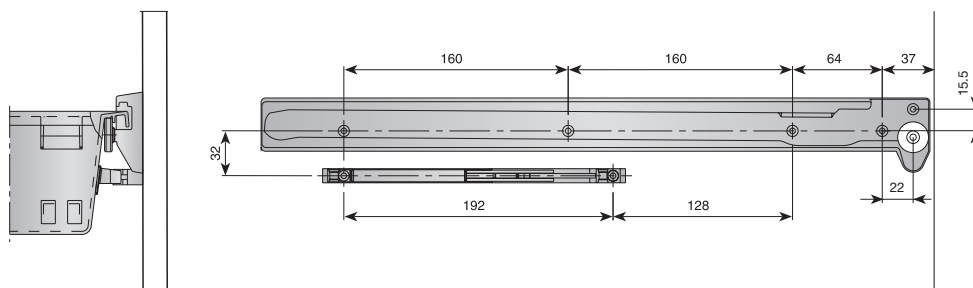

Montaje de la horquilla

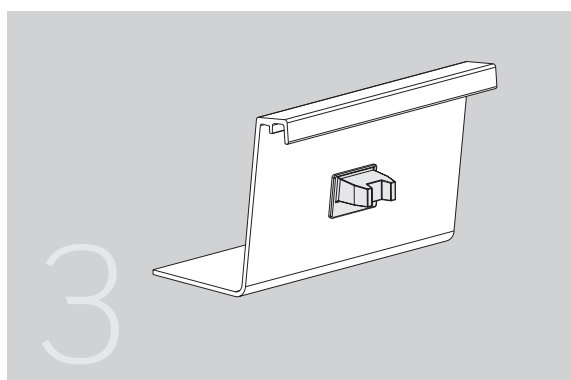
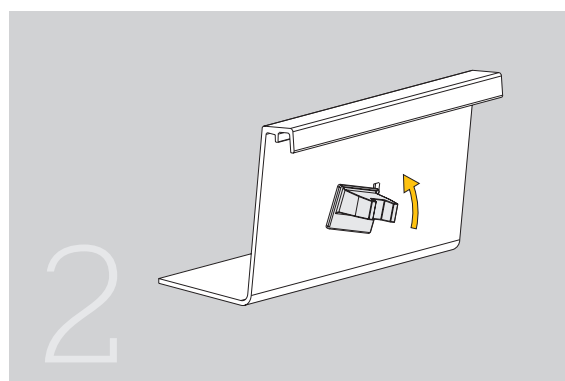
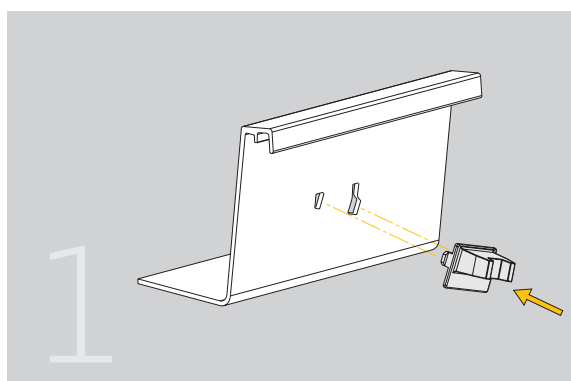

**NOTA**

El sistema de autocierre amortiguado INDAmatic va instalado en el lado derecho del cajón.