

EXCÉNTRICA CLOCK Ø35

De espiral

- > El conector para las grandes cargas, de 500 Kg. de resistencia .
- > Elimina la posibilidad de aflojamientos debido a la vibración.
- > Para pernos de M6, M8 y de unión doble y tableros de 19 a 34mm. de espesor.
- > Se fabrica ahora en una única pieza, para maximizar su rendimiento.



1 EXCÉNTRICA CLOCK Y TAPAS

Evita posibles aflojamientos por vibración.
Para tableros desde 19mm.

Excéntrica clock Ø35mm de espiral.

			
Cincado		512.035.031	250
Niquelado		512.035.064	

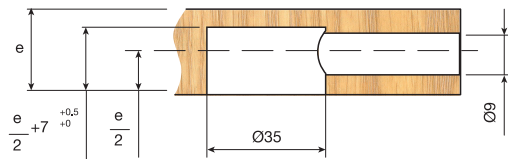
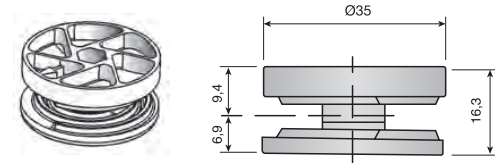

Tapa embellecedora Ø35.

		Espesor de Tablero	Tapa		
Niquelado		19-34	A	531.335.066	1.000
Blanco	RAL 9003	>26mm	B	530.500.003	
Marrón	RAL 8016	>26mm	B	530.500.014	
Negro	RAL 9005	>26mm	B	530.500.025	
Niquelado		>26mm	B	530.500.062	

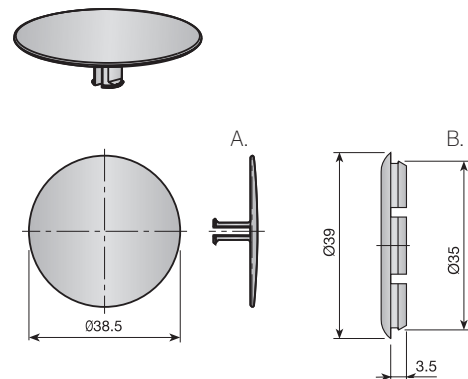

Excéntrica clock de acero Ø35mm de espiral.

			
Gris RAL 7043		513.035.106	250

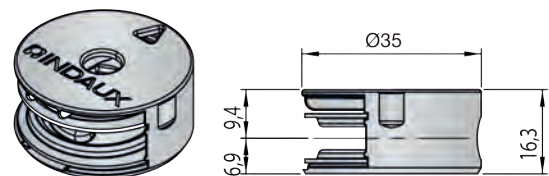

2 PERNOS

Perno de unión.

Distancia de taladrado = D		M6	M8	
35mm.	Cincado	521.735.034	521.835.031	500
55mm.	Cincado	521.755.032	521.855.036	

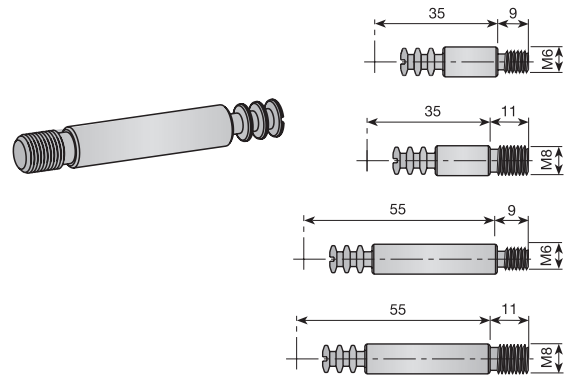
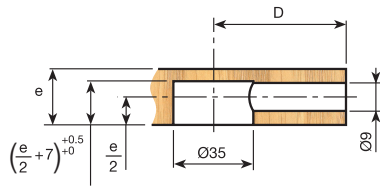

Perno de unión doble.

Cincado	522.470.034		500
---------	-------------	---	-----

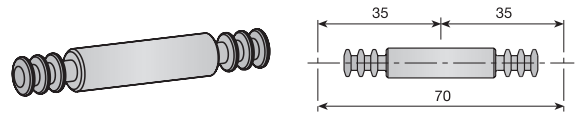
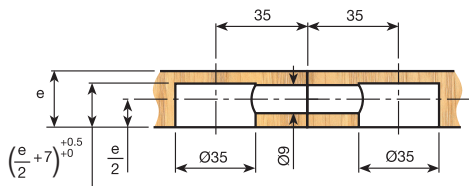

Perno de unión doble para tablero intermedio.

Cincado	522.489.030		500
---------	-------------	---	-----

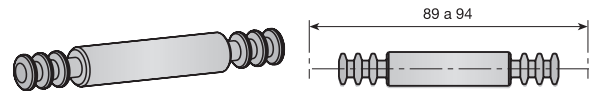
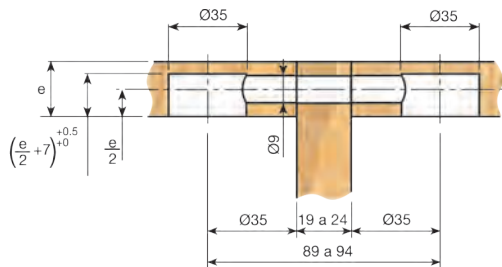

Perno de unión a escuadra.

Cincado	522.950.035		500
---------	-------------	---	-----

